

Spot-valaisimet



Made in Finland

www.candeeffect.com

Candee E.

Pidätämme oikeuden
tuotemuutoksiin.

Spotvalaisimet

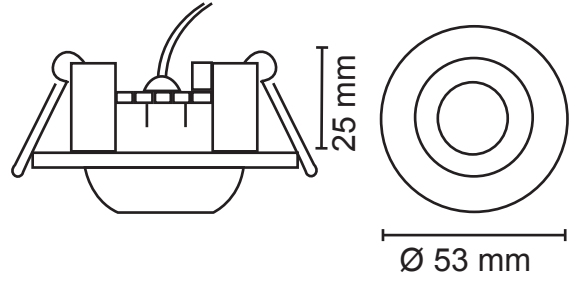

valkoinen



kromi



nikkeli



kulta

LedSpot55

Rakenne	Metallirunko, valaisinosä käännettävä kalansilmä
Tehonsyöttö	Led-driverilla virtaohjauksen kautta 350 mA
Kytkenä	Sarjaan
Käyttölämpötila	- 40 °C - + 60 °C
Käyttöikä	100.000 h valonalenemalla -30 %
Takuu	Valoysikkö 6 vuotta

Made in Finland

www.candeeffect.com

Candee L.

Pidätämme oikeuden tuotemuutoksiin.

Spotvalaisimet

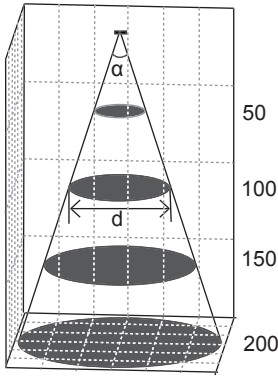

Warm White	Säteilykulma 19 °	CRI 80
Etäisyys valonlähteestä (cm)	Valaistusvoimakkuus max (lx)	Keilan leveys (d)
50 cm	790	17 cm
100 cm	210	34 cm
150 cm	90	49 cm
200 cm	50	66 cm

Cool White	Säteilykulma 18 °	CRI 70
Etäisyys valonlähteestä (cm)	Valaistusvoimakkuus max (lx)	Keilan leveys (d)
50 cm	1210	16 cm
100 cm	320	31 cm
150 cm	150	45 cm
200 cm	80	62 cm

Neutral White	Säteilykulma 17 °	CRI 80
Etäisyys valonlähteestä (cm)	Valaistusvoimakkuus max (lx)	Keilan leveys (d)
50 cm	1180	15 cm
100 cm	310	29 cm
150 cm	140	44 cm
200 cm	80	58 cm

	Valolähteen lähtövaloteho
warm white	60 lm
neutral white	70 lm
cool white	90 lm

Vähimmäisasennussyvyys: 35 mm



Tuotenumero	Nimi		Ledin väri	W	K	Led
CEL310 204 103	LedSpot55	valolähde	warm white	1,25	2800	Rebel
CEL310 204 203	LedSpot55	valolähde	neutral white	1,25	4000	Rebel
CEL310 204 303	LedSpot55	valolähde	cool white	1,25	6000	Rebel
CEL710 055 010	Runko55	Valkoinen				
CEL710 055 020	Runko55	Kulta				
CEL710 055 030	Runko55	Nikkeli				
CEL710 055 040	Runko55	Kromi				



Pidätämme oikeuden tuotemuutoksiin.

Candeo L.

Made in Finland

www.candeeffect.com

Spotvalaisimet

Led-valolähde

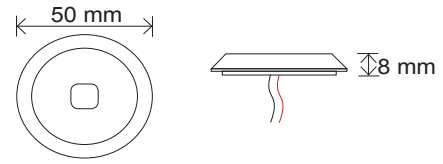

LedSpot100; pyöreä, kiinteä

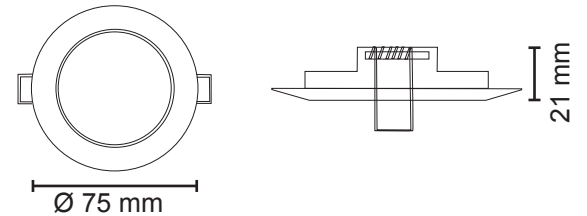

valkoinen



teräs

Tilauksesta: kulta, satiinikulta, kromi, satiinikromi, pronssi

LedSpot100; pyöreä, käännettävä

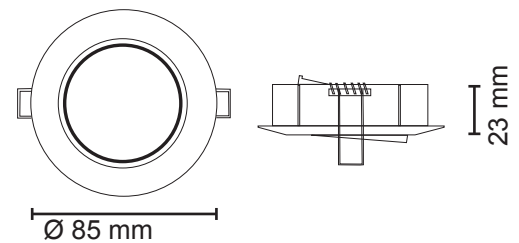

valkoinen



teräs

Tilauksesta: kulta, satiinikulta, kromi, satiinikromi, pronssi

Rakenne	Metallirunko, valaisinosajoko kiinteä tai käännettävä
Tehosyöttö	Led-driverilla virtaohjauksen kautta 350 mA tai 700 mA
Kytkenä	Sarjaan
Käyttölämpötila	- 40 °C - + 60 °C
Käyttöikä	yli 100.000 h valonalenemalla -30 %
Takuu	Valoysikkö 6 vuotta

LedSpot100

Made in Finland

www.candeeffect.com

Candee E.

Pidätämme oikeuden tuotemuutoksiin.

Spotvalaisimet

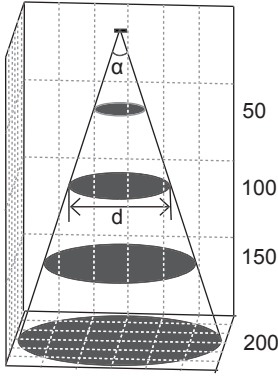

Warm White	Säteilykulma 38 °	CRI 80
Etäisyys valonlähteestä (cm)	Valaistusvoimakkuus max (lx) 350 / 700 mA	Keilan leveys (d)
50 cm	230 / 380	33 cm
100 cm	60 / 98	66 cm
150 cm	25 / 44	99 cm
200 cm	15 / 25	131 cm

Cool White	Säteilykulma 33 °	CRI 70
Etäisyys valonlähteestä (cm)	Valaistusvoimakkuus max (lx) 350 / 700 mA	Keilan leveys (d)
50 cm	415 / 670	30 cm
100 cm	105 / 170	60 cm
150 cm	45 / 75	89 cm
200 cm	25 / 40	119 cm

Neutral White	Säteilykulma 35 °	CRI 80
Etäisyys valonlähteestä (cm)	Valaistusvoimakkuus max (lx) 350 / 700 mA	Keilan leveys (d)
50 cm	305 / 490	31 cm
100 cm	80 / 125	62 cm
150 cm	35 / 55	93 cm
200 cm	20 / 31	125 cm

	Valolähteen lähtövaloteho 350 / 700 mA
warm white	60 / 100 lm
neutral white	60 / 100 lm
cool white	90 / 150 lm

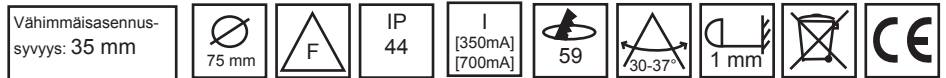

LedSpot100; pyöreä, kiinteä runko

Tuotenumero	Nimi		Ledin väri	W (350/700 mA)	K	Led
CEL310 214 174	Halled3	Valolähde	warm white	1,25 / 2,25	2800	Rebel
CEL310 214 274	Halled3	Valolähde	neutral white	1,25 / 2,25	4000	Rebel
CEL310 214 374	Halled3	Valolähde	cool white	1,25 / 2,25	6000	Rebel
CEL710 100 010	Runko100P	Valkoinen				
CEL710 100 060	Runko100P	Teräs				

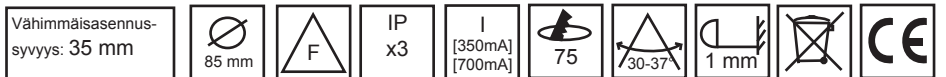

LedSpot100; pyöreä, käännettävä

Tuotenumero	Nimi		Ledin väri	W (350/700 mA)	K	Led
CEL310 214 174	Halled3	Valolähde	warm white	1,25 / 2,25	2800	Rebel
CEL310 214 274	Halled3	Valolähde	neutral white	1,25 / 2,25	4000	Rebel
CEL310 214 374	Halled3	Valolähde	cool white	1,25 / 2,25	6000	Rebel
CEL710 101 010	Runko100PK	Valkoinen				
CEL710 101 060	Runko100PK	Teräs				



Pidätämme oikeuden tuotemuutoksiin.

Candeo L.

Made in Finland

www.candeeffect.com

Spotvalaisimet

LedSpot100; neliö, käännettävä

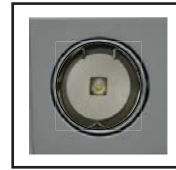
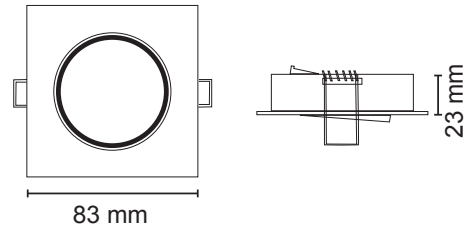

valkoinen



teräs

LedSpot100; neliö, lasilla

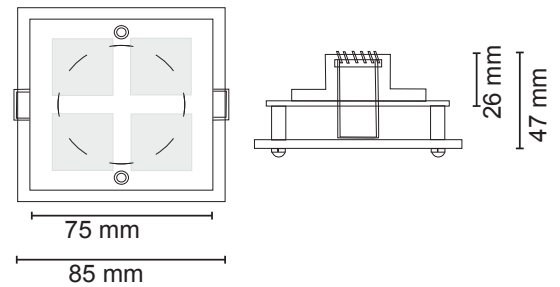

Lasi hiotulla faseteilla,
runko kromi

Rakenne	Metallirunko, valaisinosa joko kiinteä tai käännettävä
Tehonsyöttö	Led-driverilla virtaohjauksen kautta 350 mA tai 700 mA
Kytkenä	Sarjaan
Käyttölämpötila	- 40 °C - + 60 °C
Käyttöikä	yli 100.000 h valonalenemalla -30 %
Takuu	Valoyksikkö 6 vuotta

LedSpot100

Made in Finland

www.candeeffect.com

Candee E.

Pidätämme oikeuden
tuotemuutoksiin.

Spotvalaisimet

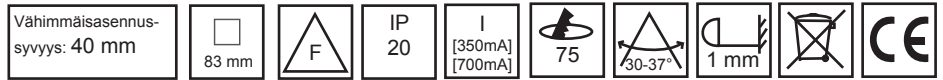

LedSpot100; neliö, käännettävä

Tuotenumero	Nimi		Ledin väri	W (350 / 700 mA)	K	Led
CEL310 214 174	Halled3	Valolähde	warm white	1,25 / 2,25	2800	Rebel
CEL310 214 274	Halled3	Valolähde	neutral white	1,25 / 2,25	4000	Rebel
CEL310 214 374	Halled3	Valolähde	cool white	1,25 / 2,25	6000	Rebel
CEL710 111 010	Runko100NK	Valkoinen				
CEL710 111 060	Runko100NK	Teräs				



LedSpot100; neliö, lasilla

Tuotenumero	Nimi		Ledin väri	W (350 / 700 mA)	K	Led
CEL310 214 174	Halled3	Valolähde	warm white	1,25 / 2,25	2800	Rebel
CEL310 214 274	Halled3	Valolähde	neutral white	1,25 / 2,25	4000	Rebel
CEL310 214 374	Halled3	Valolähde	cool white	1,25 / 2,25	6000	Rebel
CEL710 120 040	Runko100L	Kromi + Lasi				



Pidätämme oikeuden
tuotemuutoksiin.

Candeo L.

Made in Finland

www.candeeffect.com

Spotvalaisimet

ThinSQ7

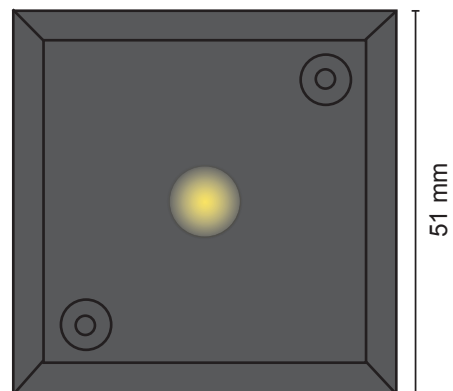
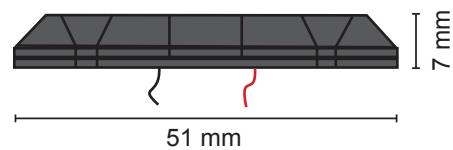

Rakenne	Maalattu alumiini Erillistilauksella myös mahdollista maalata haluttuun värisävyyen
Tehonsyöttö	Led-driverilla virtaohjauksen kautta 350 mA tai 700 mA
Kytkenä	Sarjaan
Käyttölämpötila	- 40 °C - + 60 °C
Käyttöikä	100.000 h valonalenemalla -30 %
Takuu	Valoyksikkö 6 vuotta

Made in Finland

www.candeeffect.com

Candee E.

Pidätämme oikeuden
tuotemuutoksiin.

Spotvalaisimet

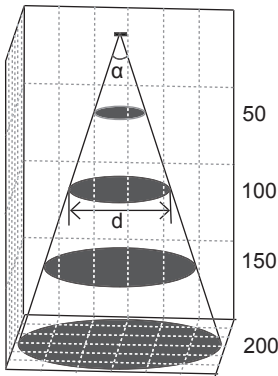

Warm White	Säteilykulma 29 °	CRI 80
Etäisyys valonlähteestä (cm)	Valaistusvoimakkuus max (lx) 350 / 700 mA	Keilan leveys (d)
50 cm	280 / 480	26 cm
100 cm	70 / 120	51 cm
150 cm	30 / 54	77 cm
200 cm	15 / 30	103 cm

Cool White	Säteilykulma 26 °	CRI 70
Etäisyys valonlähteestä (cm)	Valaistusvoimakkuus max (lx) 350 / 700 mA	Keilan leveys (d)
50 cm	620 / 1115	23 cm
100 cm	155 / 280	45 cm
150 cm	70 / 125	69 cm
200 cm	40 / 71	92 cm

Neutral White	Säteilykulma 25 °	CRI 80
Etäisyys valonlähteestä (cm)	Valaistusvoimakkuus max (lx) 350 / 700 mA	Keilan leveys (d)
50 cm	350 / xx	22 cm
100 cm	90 / xx	45 cm
150 cm	40 / xx	68 cm
200 cm	20 / xx	90 cm

	Valolähteen lähtövaloteho 350 / 700 mA
warm white	60 / 100 lm
neutral white	70 / xx lm
cool white	90 / 150 lm

Pinta-asennettava led-valaisin, johtojen läpivienti 25 mm



ThinSQ7; pinta-asennettava valaisin

Tuotenumero	Nimi	Runko	Ledin väri	W (350 / 700 mA)	K	Led
CEL110 212 175	ThinSQ7	Alumiini, RAL9006	warm white	1,25 / 2,25	2800	Rebel
CEL110 212 275	ThinSQ7	Alumiini, RAL9006	neutral white	1,25 / 2,25	4000	Rebel
CEL110 212 375	ThinSQ7	Alumiini, RAL9006	cool white	1,25 / 2,25	6000	Rebel



Pidätämme oikeuden tuotemuutoksiin.

Candeo L.

Made in Finland

www.candeeffect.com

Driverit, ohjaimet

Product code	CEL07391
Type	LED 10W DC 350 mA Aluminium housing
Number of LEDs	1 - 7 (LEDsin series)
Casing	Aluminium casing
Dimension (mm)	23 x 40 x 81
Weight	165 g
Tc Max	90° C
Connection	Output / Input wires
Load	1 -10VA
Input	120-240V 50Hz
Output current	350 mA
Output voltage	2 - 29 V
	IP67
Warranty	4 years
Manufacturer	Lightech

LED10W DC 350mA,
Aluminium casing

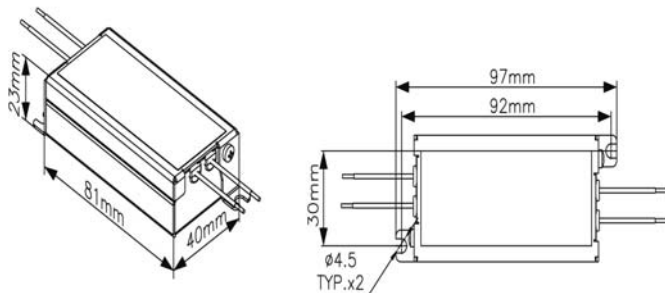

Product code	CEL07392
Type	LED 10W DC 350 mA
Number of LEDs	1 - 7 (LEDs in series)
Casing	Plastic casing
Dimension (mm)	27 x 40 x 100
Weight	90 g
Tc Max	90° C
Connection	Terminal block connection
Load	1 -10VA
Input	120-240V 50Hz
Output current	350 mA
Output voltage	2 - 29 V
Warranty	4 years
Manufacturer	Lightech
	Only inside use

LED10W DC 350mA,
Plastic casing

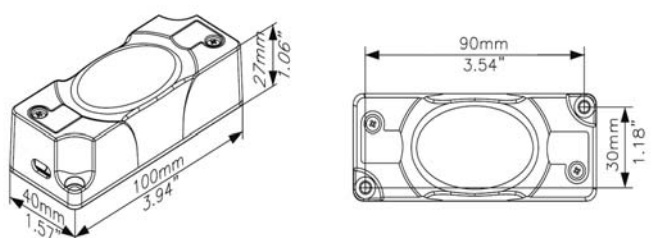

Product code	CEL07393
Type	LED 10W DC 350 mA Plug-in
Number of LEDs	1 - 7 (LEDs in series)
Casing	Plastic casing (silver)
Dimension (mm)	33 x 38 x 80
Weight	150 g
Tc Max	90° C
Connection	Output 1,5 m double insulated wire
Load	1 -10VA
Input	95-265V 50Hz
Output current	350 mA
Output voltage	2 - 28 V
Warranty	4 years
Manufacturer	Lightech

LED10W DC 350mA,
Plug-In

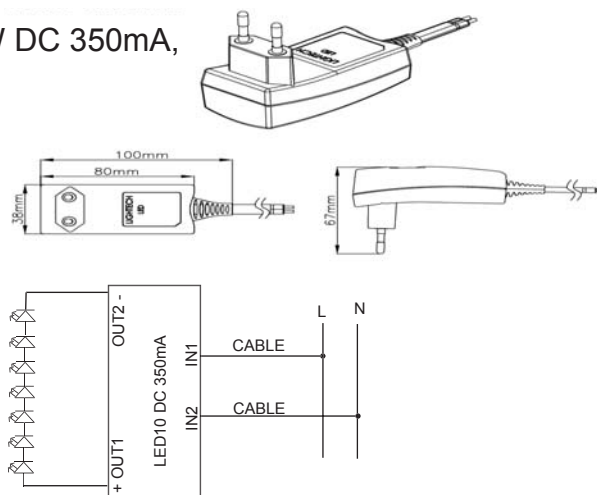

Driverit, ohjaimet

Product code	CEL10041
Type	LED 18W DC 350 mA Aluminium housing
Number of LEDs	4 - 12 (LEDs in series)
Dimming	1 - 10 V Dimming control
Casing	Aluminium casing
Dimension (mm)	30,5 x 40 x 133
Weight	300 g
Tc Max	90° C
Connection	Output / Input wires
Input	240V 50Hz
Output current	350 mA
Output voltage	8 - 48 V
	IP67
Warranty	4 years
Manufacturer	Lightech

LED18W DC 350mA

From 4 to 12 leds
in series.

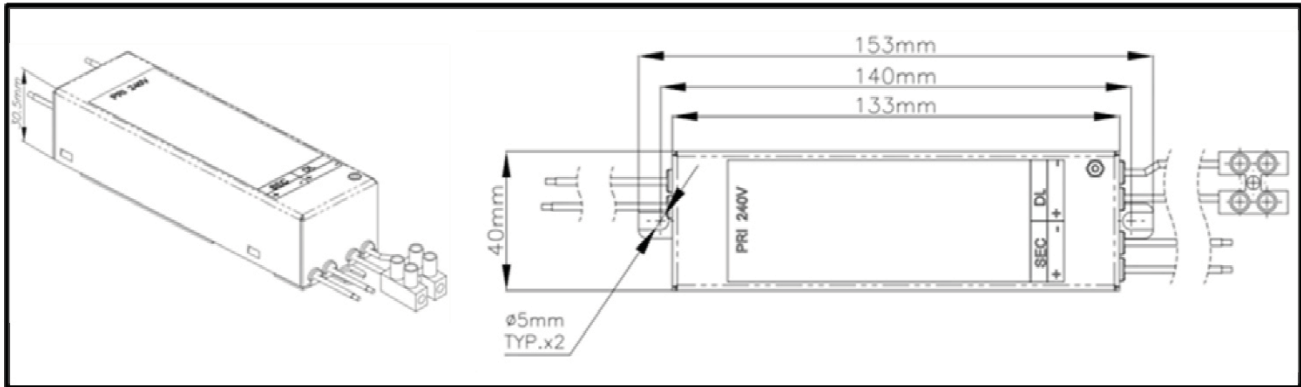
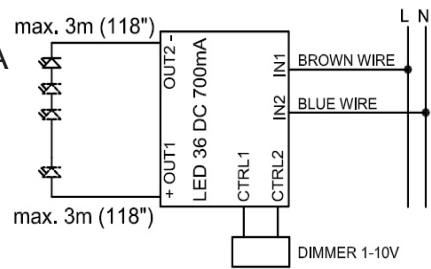

Product code	CEL10042
Type	LED 36W DC 700 mA Aluminium housing
Number of LEDs	4 - 12 LEDs in series
Dimming	1 - 10 V Dimming control
Casing	Aluminium casing
Dimension (mm)	30,5 x 40 x 133
Weight	300 g
Tc Max	90° C
Connection	Output / Input wires
Input	240V 50Hz
Output current	700 mA (4 - 12 LEDs)
Output voltage	8 - 48 V
	IP67
Warranty	4 years
Manufacturer	Lightech

LED36W DC 700mA

LED 700mA
From 4 to 12 leds
in series.

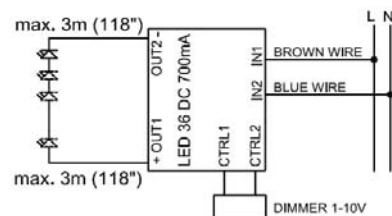

Valmistaja:
Savled /Diranet Oy
Laitaatsillantie 3
57170 SAVONLINNA
FINLAND
Puh. 015 555 0031

Made in Finland

www.candeeffect.com

Candee E.

Pidätämme oikeuden
tuotemuutoksiin.